

# Networking

Fall 2022

# Digital Transmission

- How to transmit data digitally
  - Digital to digital conversion converts digital data to a digital signal
  - Analog to digital conversion samples an analog signal
- Transmission modes:
  - Serial
  - Parallel

# Digital to Digital Conversion

# Line Coding

- Line coding converts digital data to digital signals
  - Data is given as a sequence of bits in computer memory
  - Sender encodes a bit sequence into a digital signal
  - Receiver decodes into a bit sequence

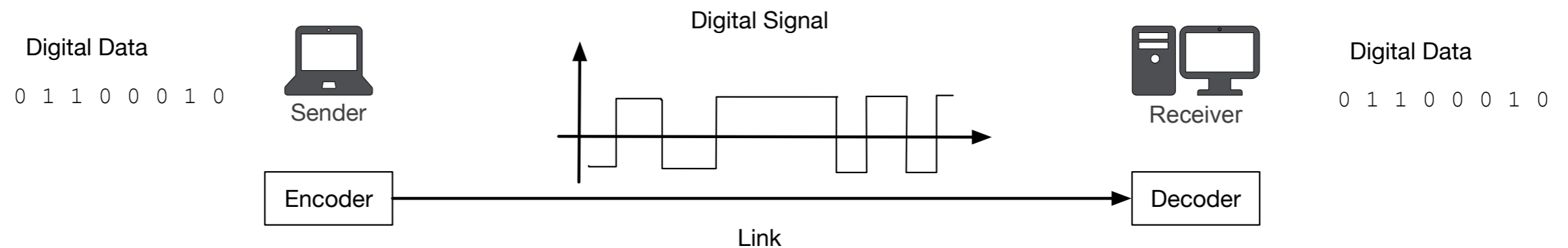

# Signal Element vs. Data Element

- Data element is the smallest entity that represents information: a bit
- Signal element: shortest unit of a signal
- Typically: Data element corresponds to  $r$  signal elements

# Signal Elements vs. Data Elements

- $r = 1$

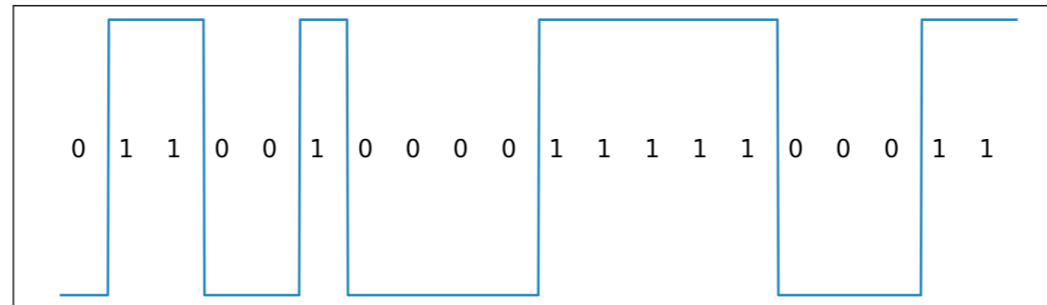

- one signal element per data bit

- $r = \frac{1}{2}$

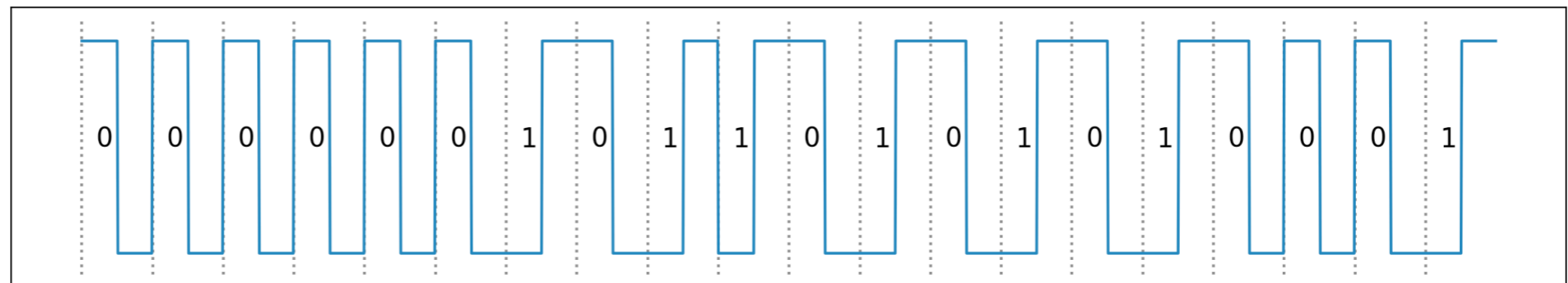

- two signal elements (up / down) per data bit
  - (Manchester encoding)

# Signal Elements vs. Data Elements

- $r = 2$

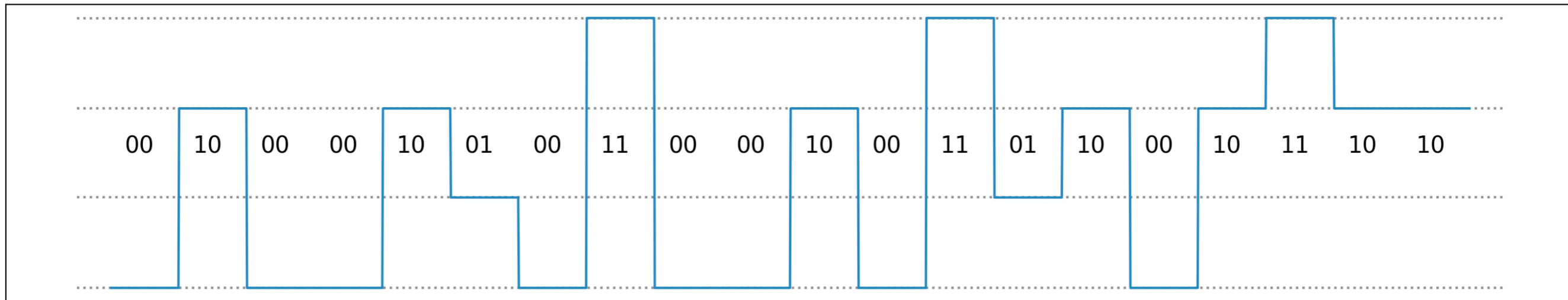

- one signal element per two data bits

# Signal Elements vs. Data Elements

- Self-timing codes
  - Timing information can be obtained from a clock
    - which needs to be synchronized
  - Codes can make synchronization easier
  - Codes can be self-timing:
    - E.g. Manchester code — a transition always happen in the middle of a bit-transfer

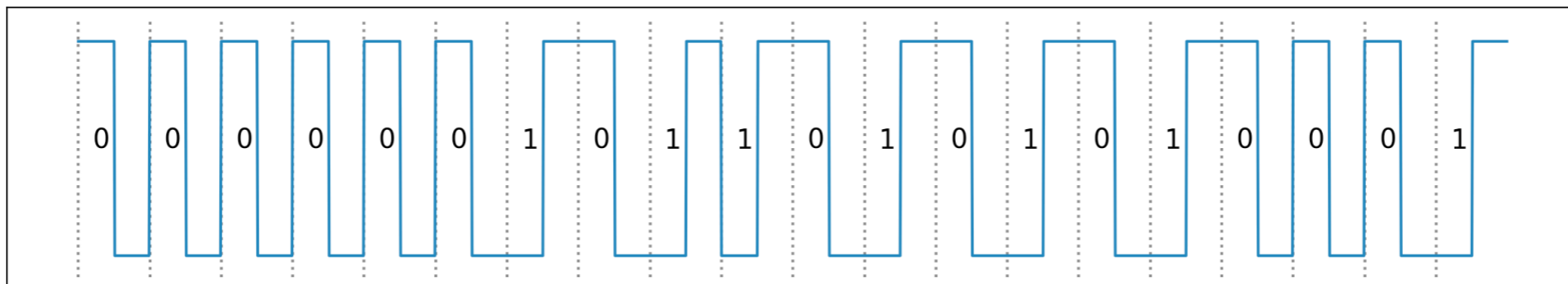



# Signal Elements vs. Data Elements

- Factor  $r$  can depend on the data
  - E.g.: Long sequences of constant signal levels make it difficult to count
    - Common coding trick: Introduce a change of signal level every so often

# Baseline Wandering

- To distinguish voltage levels:
  - Receiver uses a running average of the received signal power (the baseline)
  - A long time of fixed levels can cause baseline wandering
- Additional problem: If the voltage levels do not even out, then we send energy from one end to the other

# DC Components

- If voltage level is constant for a time:
  - Fourier analysis shows spectrum with very low frequencies (called DC frequencies)
  - Many systems cannot transport these low frequencies
    - E.g. telephone line cannot pass frequencies below 200 Hz

# Self Synchronization

- Bit intervals at the sender need to correspond to bit intervals at the receiver
  - Clocks need to be synchronized

# Self Synchronization

- Clocking:
  - Clock signals needed to interpret signal levels
  - Isochronous: clock signals are sent at the same time
    - Self-clocking: can derive the clock signal from the signal

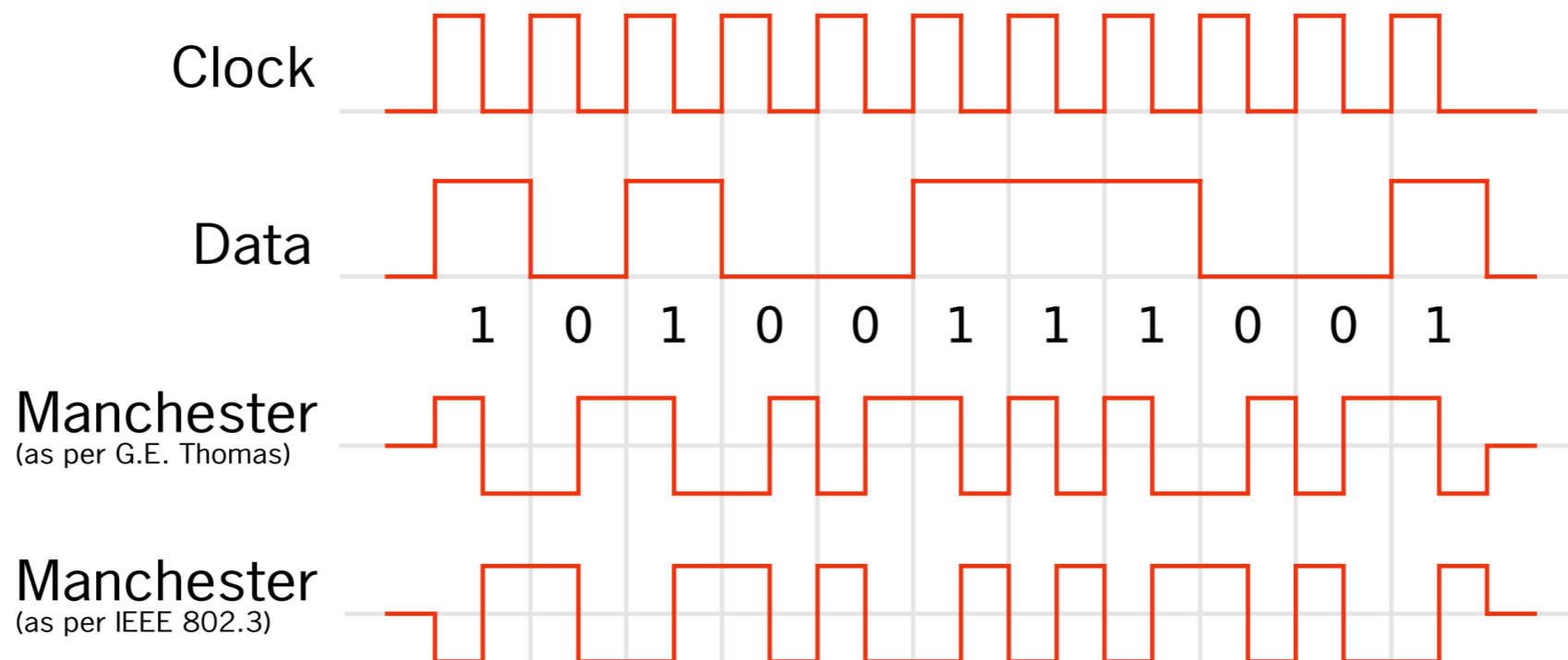

# Self Synchronization

- Clocking:
  - Anisochronous clocking: clock signals are sent at a different time
  - Self-clocking: can derive the clock signal from the signal
  - E.g. use frames which



- Or be run-length limited (no long runs of zeroes / ones)

# Signal Elements vs. Data Elements

- Data rate: number of bits sent per second
  - (bits per second / bps)
- Signal rate: number of signal elements sent per second
  - "Pulse rate", "Modulation rate", "baud rate"
- Good signal engineering:
  - Increase data rate and lower the signal rate
- Signal rate  $S$ , data rate  $N$ :  $S = N/r$

**Examples**



# 8B6T

- Eight-binary-six-ternary scheme
  - Used with 100 Base-4T cable
  - Patterns of 8 bits = 1 byte are encoded as patterns of 6 ternary signals (such as -0-0++)
  - $2^8 = 256$  values for each byte
  - $3^6 = 729$  signal pattern
  - Select signal patterns carefully:
    - Signal patterns have weight
      - Number of “+” minus number of “-”
    - Pick only signal patterns with weight 0 or 1
    - Alternatively: Invert signal patterns with weight 1 to obtain one of weight -1
    - Therefore: no DC component

# 4D-PAM5

- Used for Gb LANs using copper wire with 125 Mbaud
- 4D — four dimensional: Use four wires at the same time
- Uses five voltage levels, -2, -1, 0, 1, 2
  - Level 0 is only used for error detection

# Block Coding

- Encode blocks of  $m$  bits in blocks of  $n$  bits with (e.g.) NRZ-I
- Example:
  - 4b/5b
  - Never more than three zeroes in a row
  - Prevents clock synchronization problems
  - But adds 20% to baud rate
  - Some unused codes can be used as metadata

0000	11110
0001	01001
0010	10100
0011	10101
0100	01010
0101	01011
0110	01110
0111	01111
1000	10010
1001	10011
1010	10110
1011	10111
1100	11010
1101	11011
1110	11100
1111	11101

# Low Pass Channel

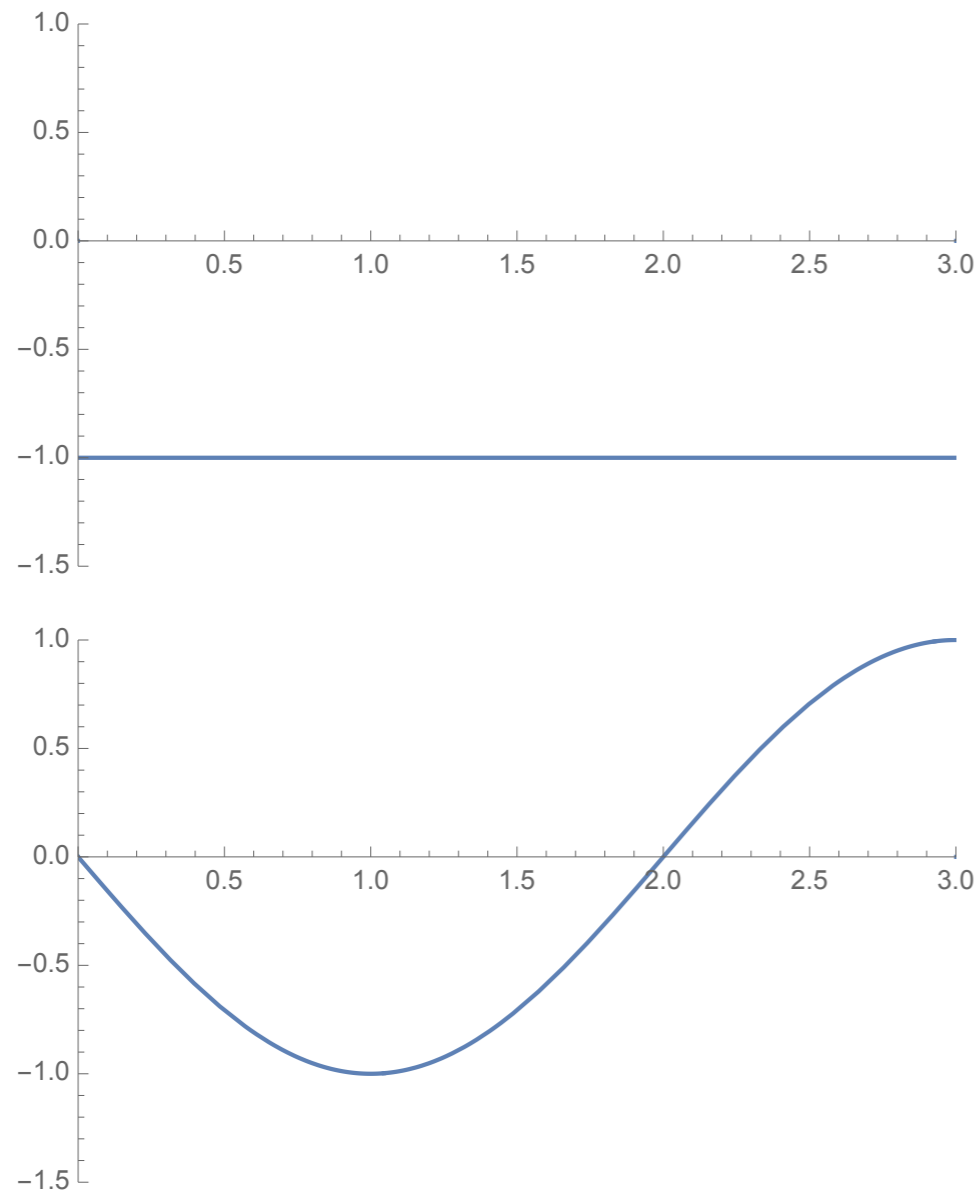

000

$f=0$

$p=180^\circ$

001

$f=N/4$

$p=180^\circ$

# Low Pass Channel

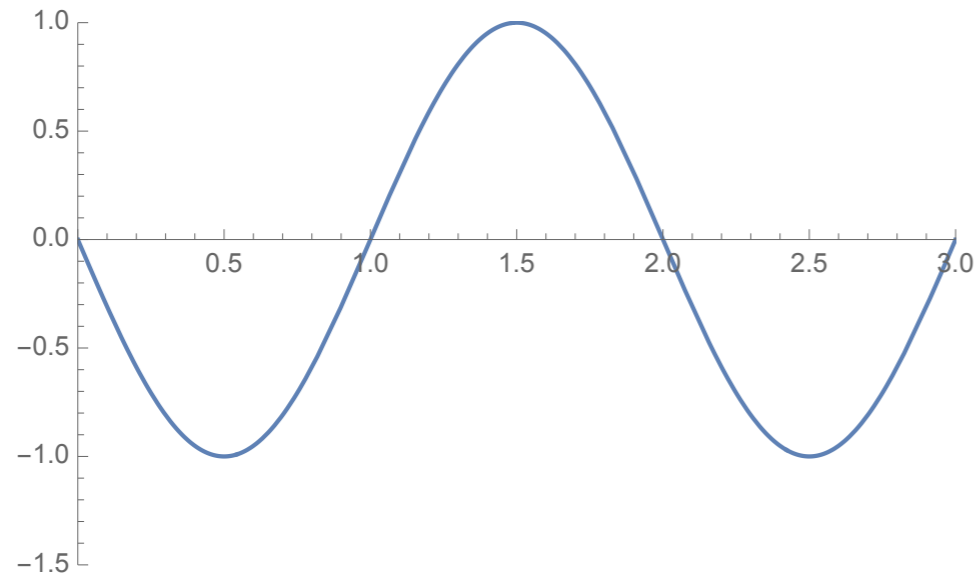

010  
 $f=N/2$   
 $p=180^\circ$

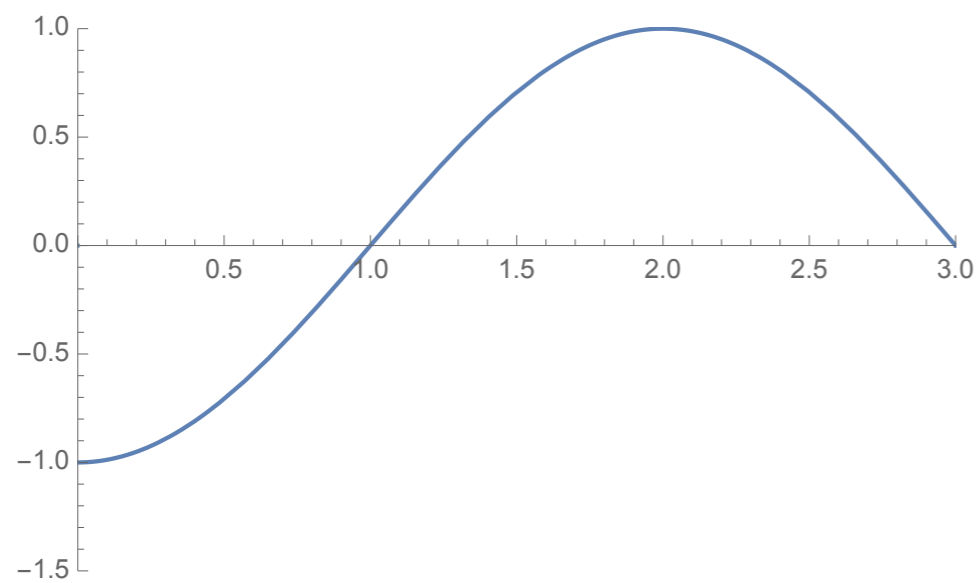

011  
 $f=N/4$   
 $p=270^\circ$

# Low Pass Channel

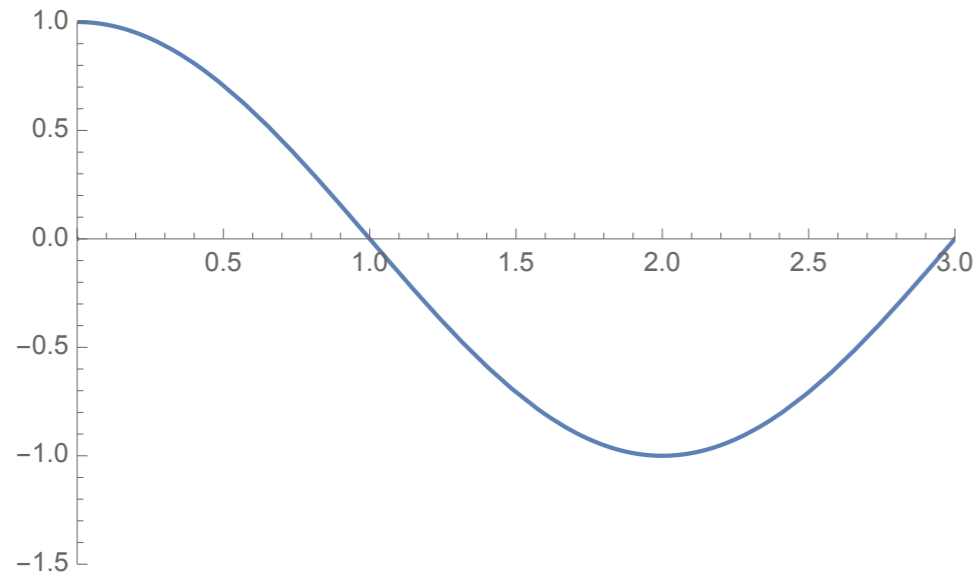

100  
 $f=N/4$   
 $p=90^\circ$

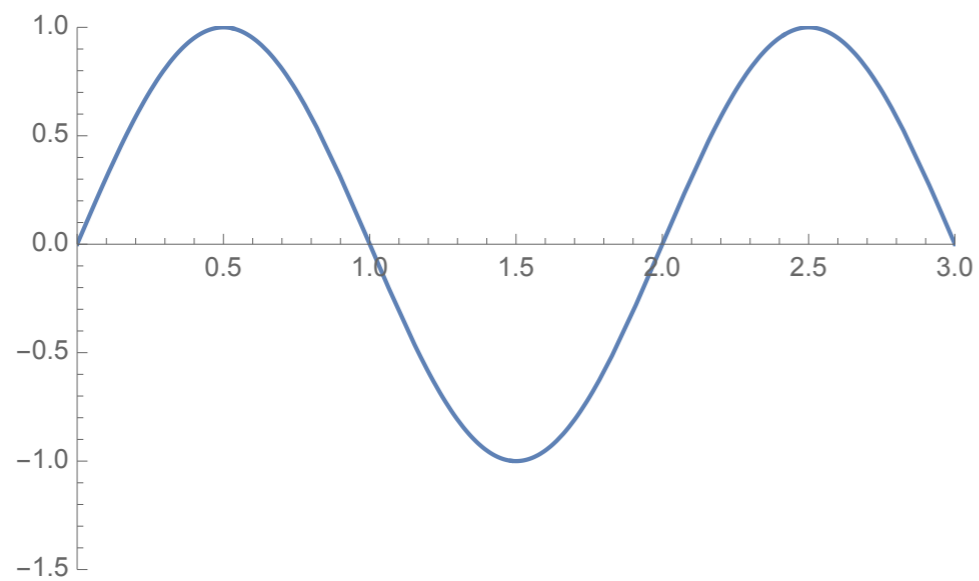

101  
 $f=N/2$   
 $p=0^\circ$

# Low Pass Channel

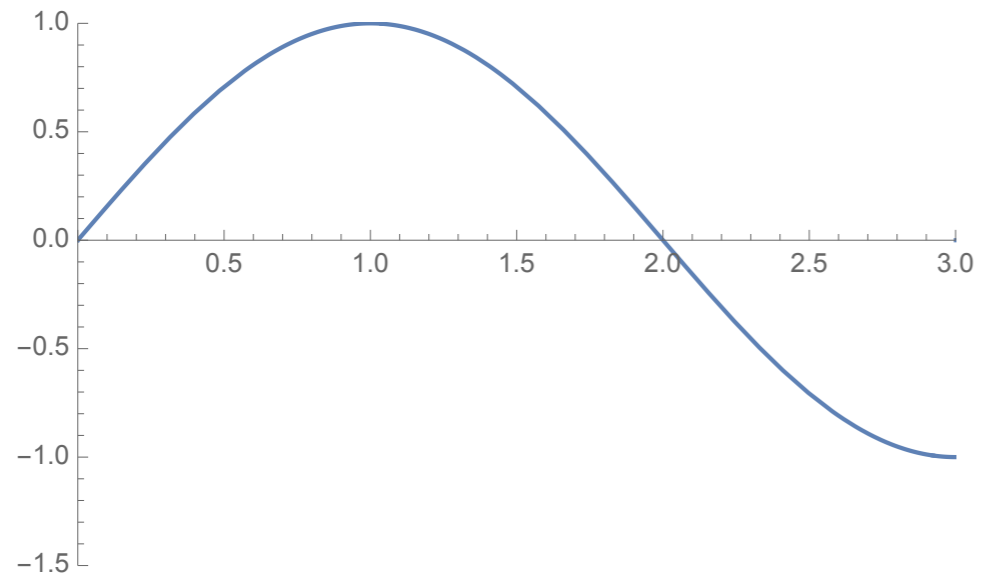

110  
 $f=N/4$   
 $p=0^\circ$

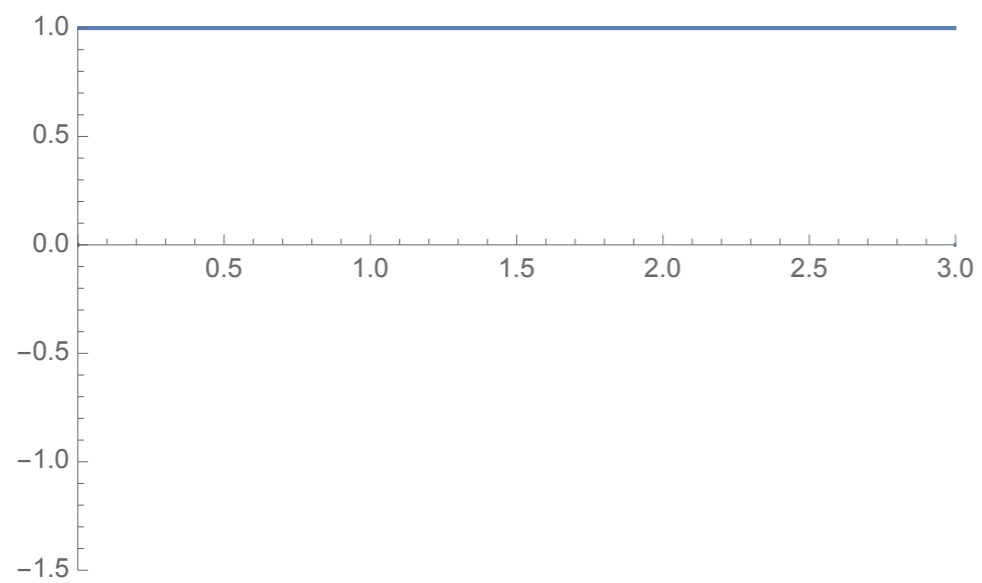

111  
 $f=0$   
 $p=0^\circ$

# Low Pass Channel

- A bandwidth of  $N/2$  is sufficient if we sample at the middle of the interval
- Higher harmonics are needed to make the signal look more digital

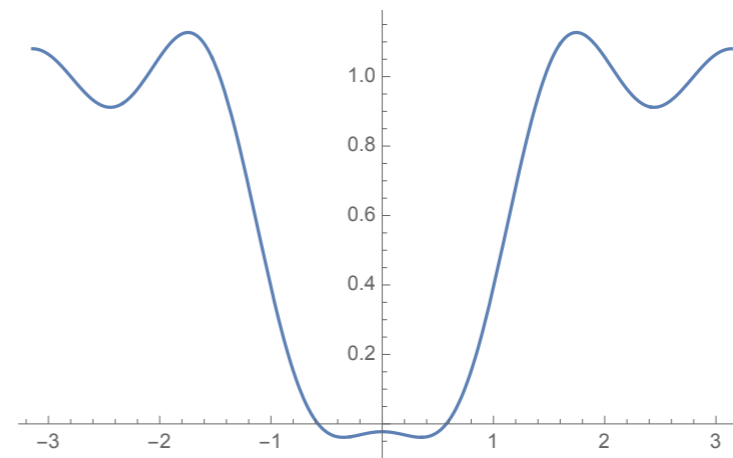
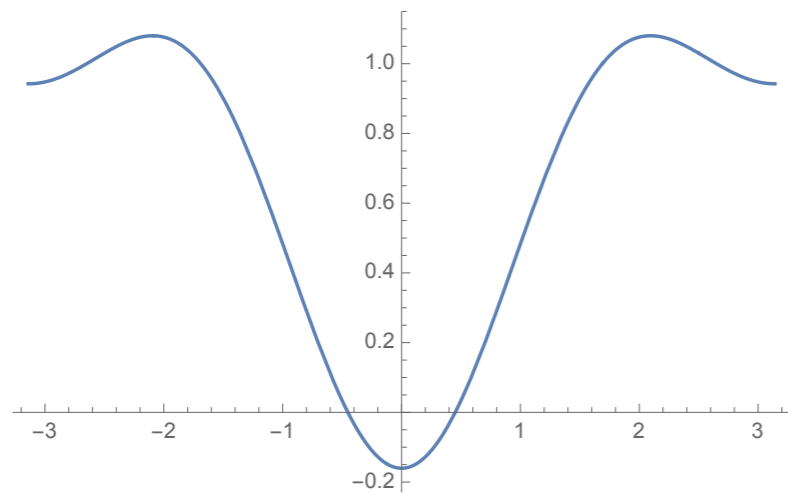

101 encoded with third and with third and fifth harmonic



# Low-pass Channel

- For better accuracy, we can use higher harmonics

## Bandwidth requirements

Bit Rate	Harmonic 1	Harmonics 1,3	Harmonics 1,3,5
1 kbps	500 Hz	1.5 KHz	2.5 KHz
10 kbps	5 KHz	15 KHz	25 KHz
1 Mbps	500 KHz	1.5 MHz	2.5 MHz

# Quiz

- How much bandwidth is required to send a 1 Gbps signal with 7 harmonics
- Answer:
  - $(1\text{Gbps}/2\text{b}) \times 7 = 3.5\text{ GHz}$

# Broadband Transmission with Modulation

- A bandpass channel consists of an interval of frequencies

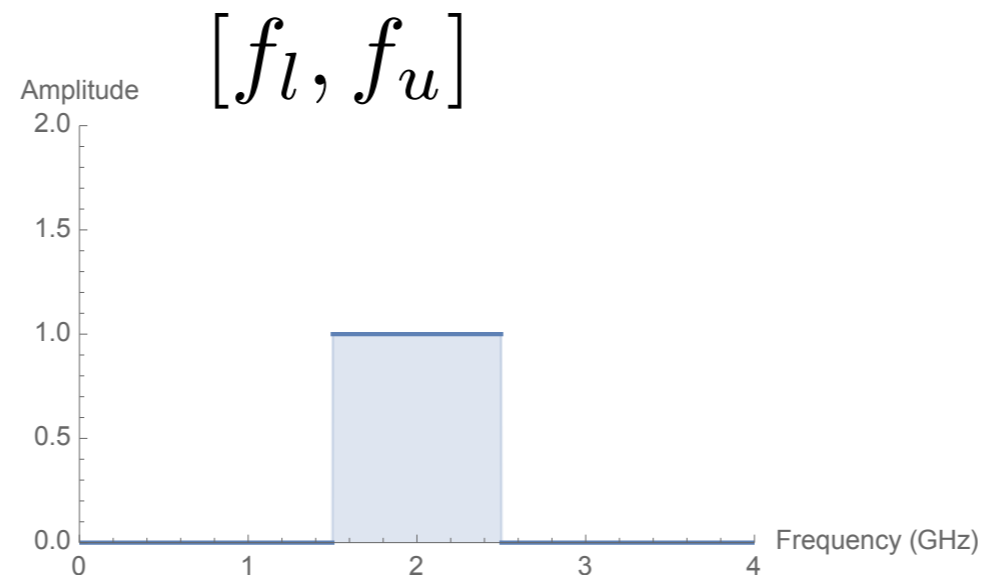

- This type of channel is more available than low—pass channels
- However, digital data now needs to be encoded

# Broadband Transmission with Modulation

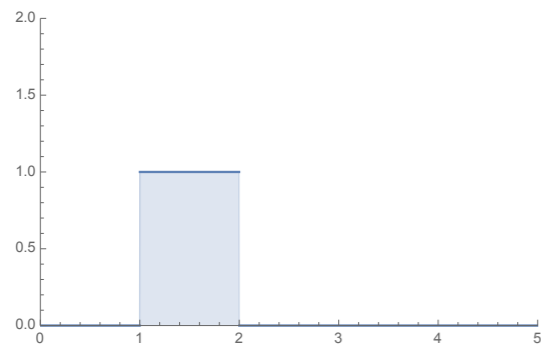

Digital / Analog  
Converter

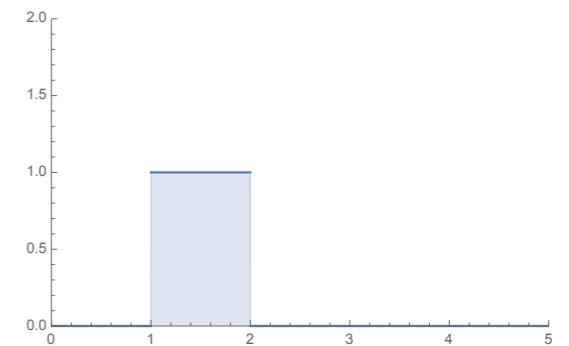
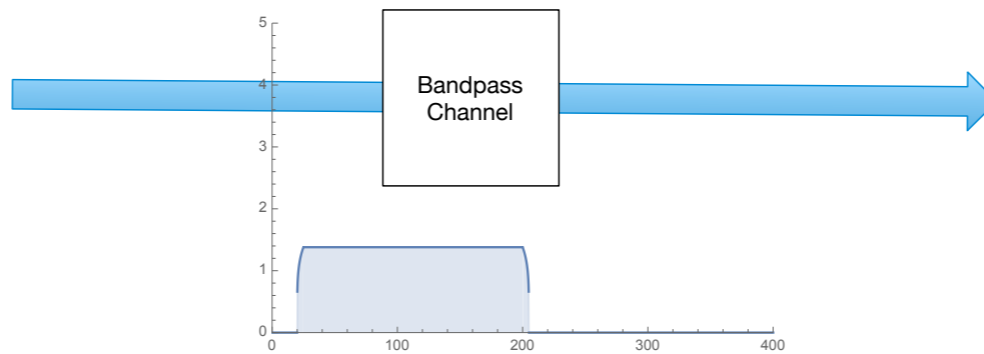
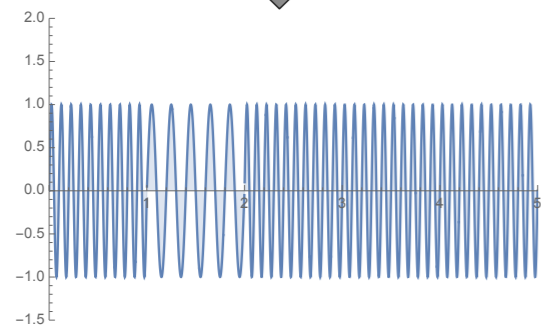

Analog/Digital  
Converter

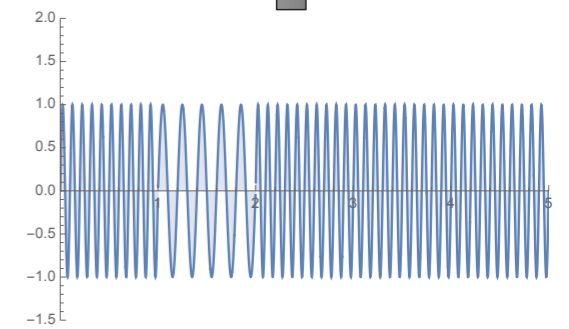

# Broadband Transmission with Modulation

- Sending computer data through a telephone subscriber line
  - Line has a bandwidth of 0 - 4 KHz
  - Treated as a low-pass channel:
    - Capacity is 8kbps
  - Treated as a broadband line with a modem
- Digital Cellular Telephony
  - Analog voice is converted to a digital signal
  - Use multiple bandwidth channels to allow concurrent talks routed through the same hardware / medium

# **Analog to Digital Conversion**

# Analog to Digital Conversion

- Sometimes need to transmit analog data
  - E.g. microphone
  - E.g. camera
- Digitization: Transform data from analog to digital
  - We consider:
    - PCM: Pulse Code Modulation
    - Delta Modulation

# Analog to Digital Conversion

- Pulse Code Modulation
  - Sampling at given time intervals  $\{i \cdot T_s \mid i = 0, 1, \dots\}$ 
    - Sampling frequency:  $f_s = \frac{1}{T_s}$
  - Encoding: results in "Quantized Signal"



# Analog to Digital Conversion

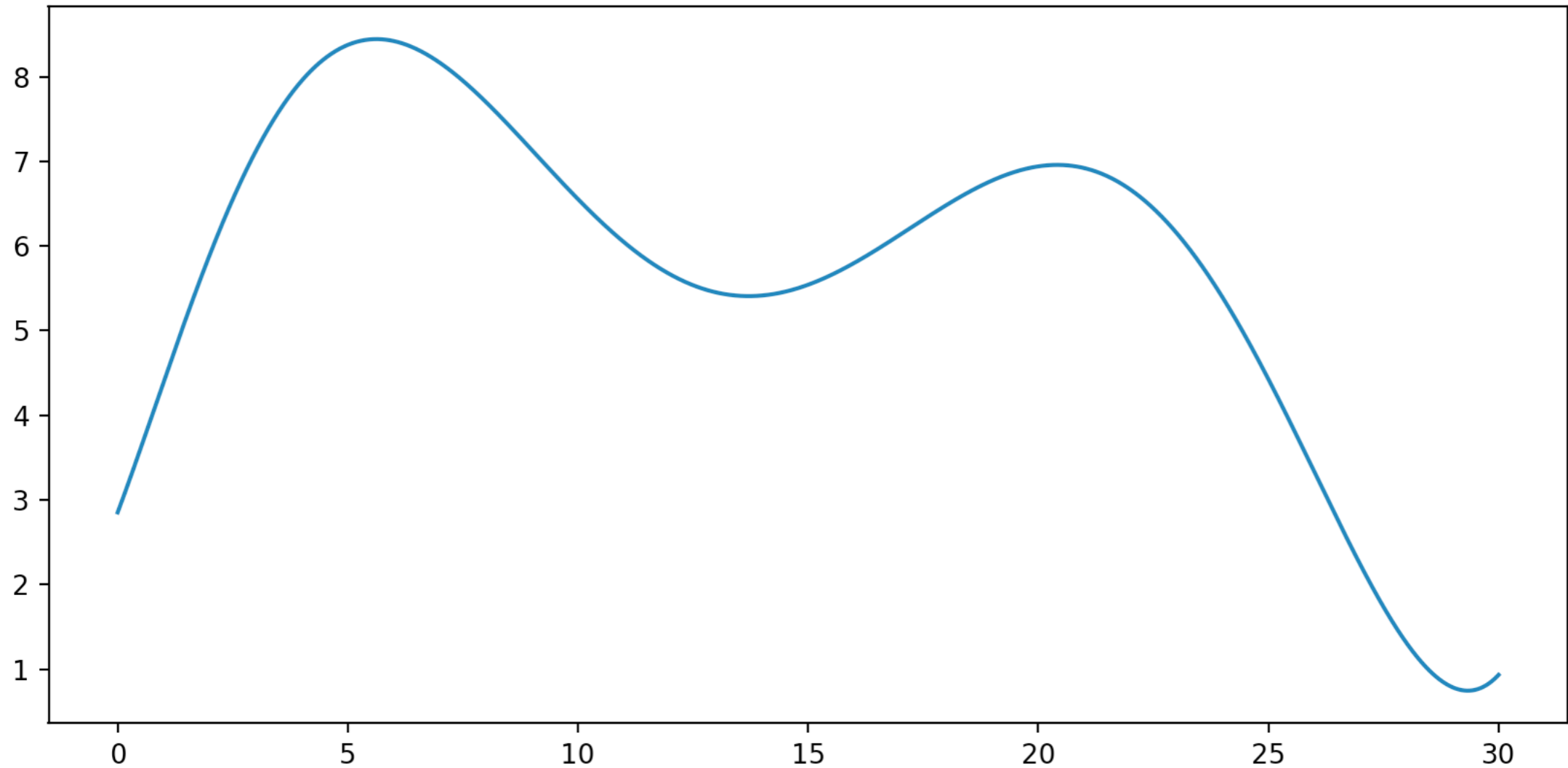

Analog Signal

# Analog to Digital Conversion

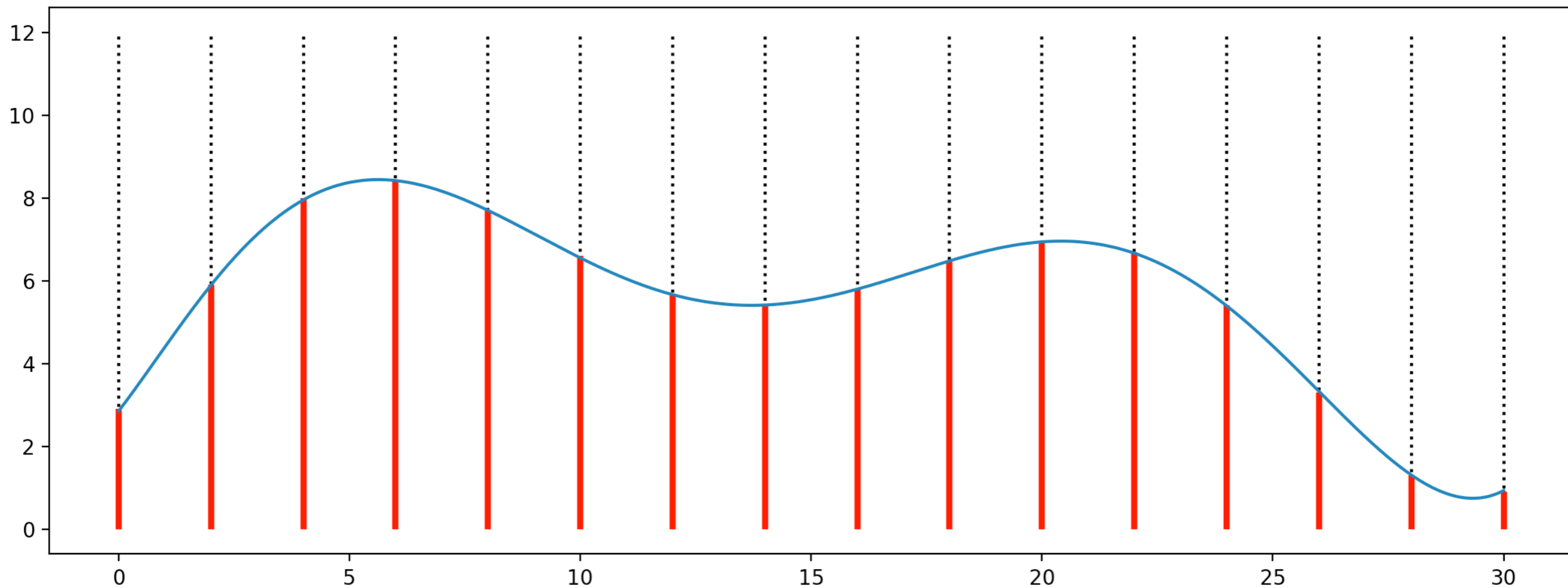

Ideal sampling: Measure pulse from analog symbols

# Analog to Digital Conversion

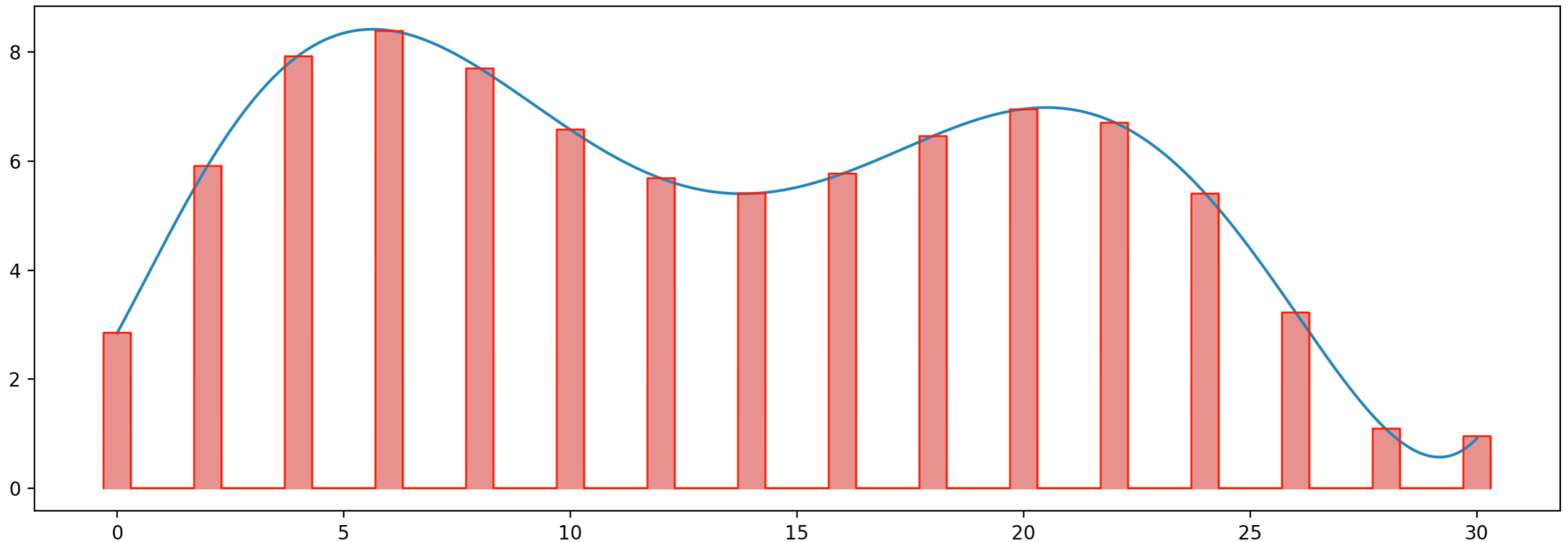

Natural sampling:

Get the average value of analog signal of a small interval by using a high-speed switch

"Flat-top sampling"

# Analog to Digital Conversion

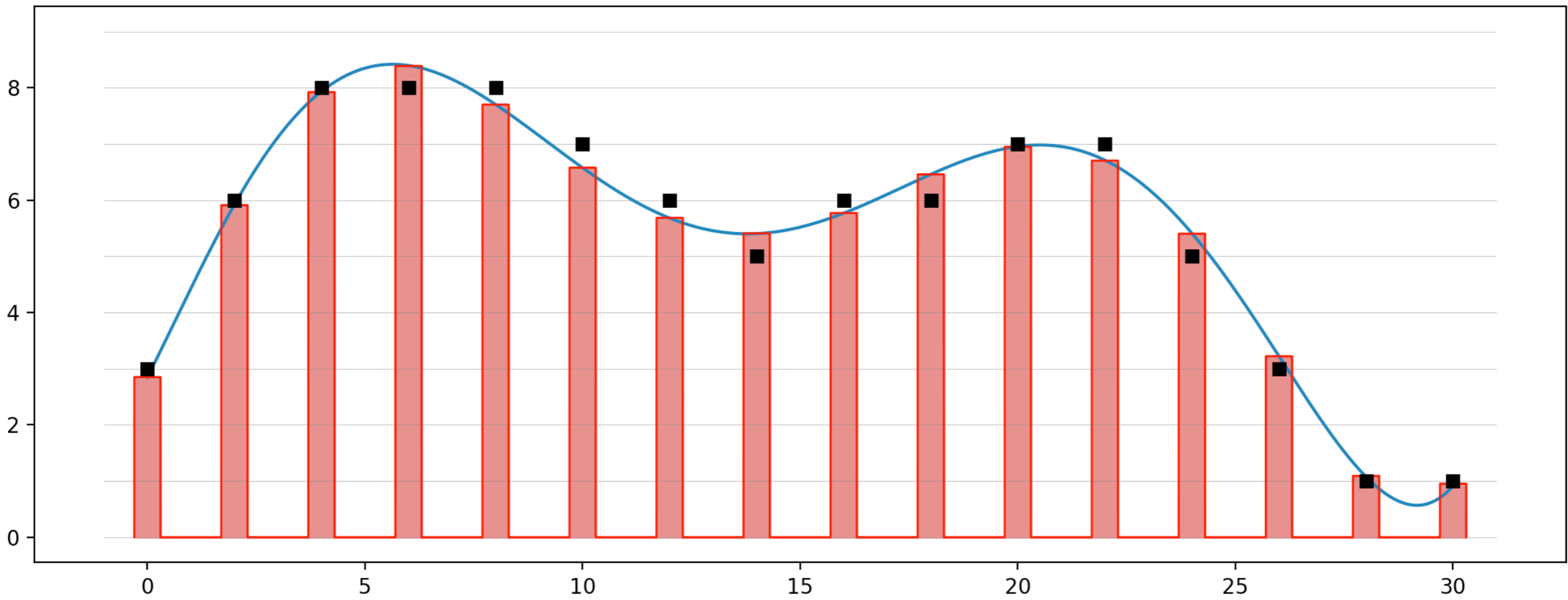

Quantize signal level

This introduces a quantization error

# Analog to Digital Conversion

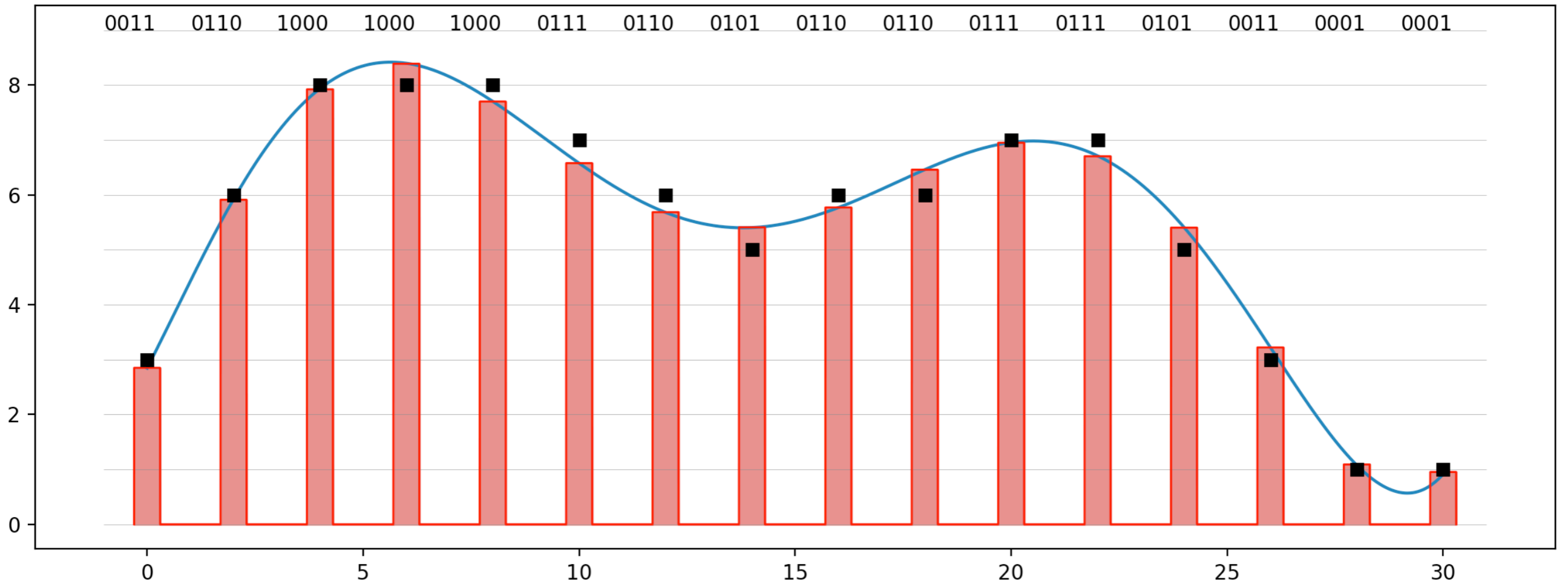

Encoding: Translate the quantized values to digital data

# Analog to Digital Conversion

- Nyquist theorem:
  - Sampling rate must be at least twice as high as highest frequency contained in the signal

# Analog to Digital Conversion

- Example:
  - Measure the position of a clock handle

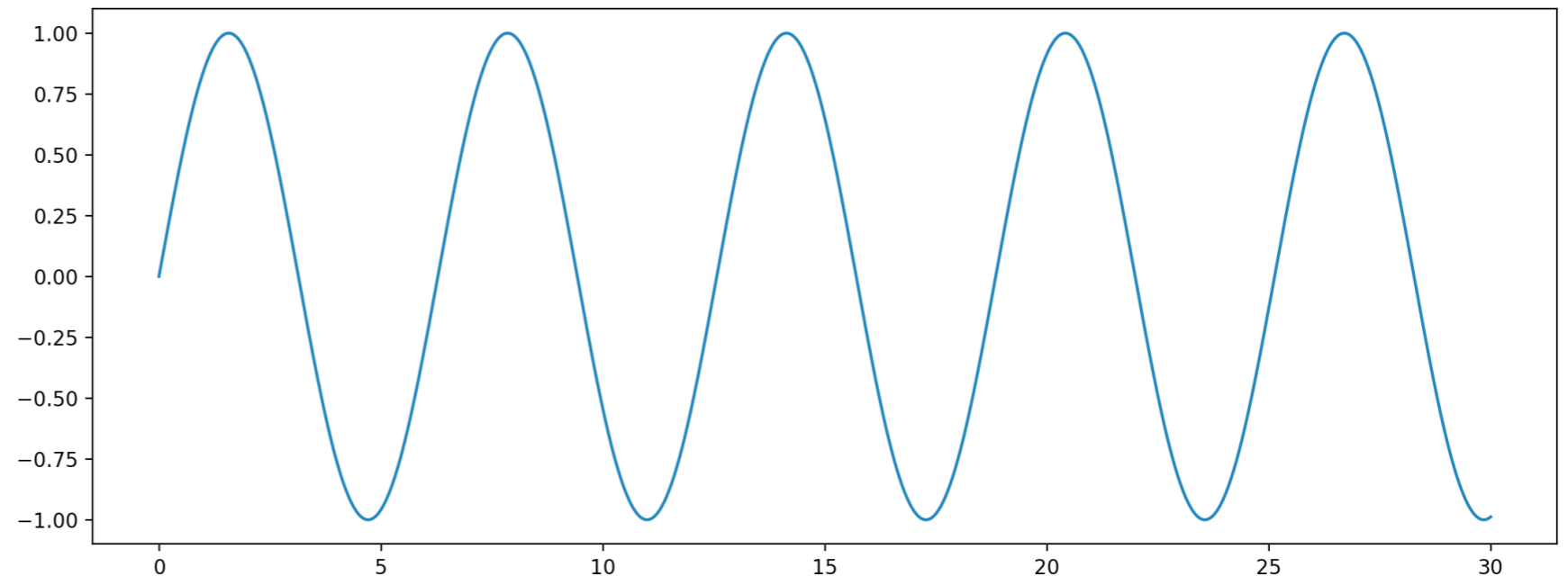

# Analog to Digital Conversion

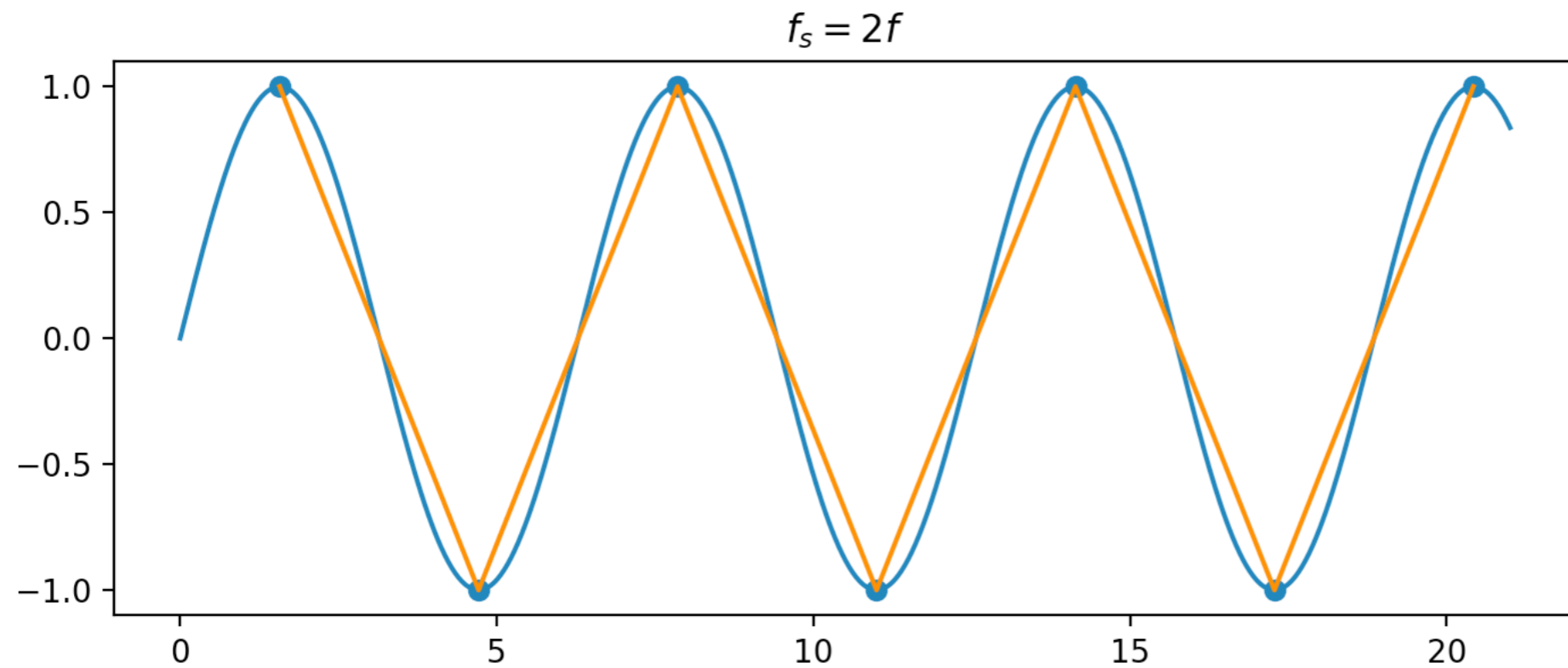



# Analog to Digital Conversion

$$f_s = 4f$$

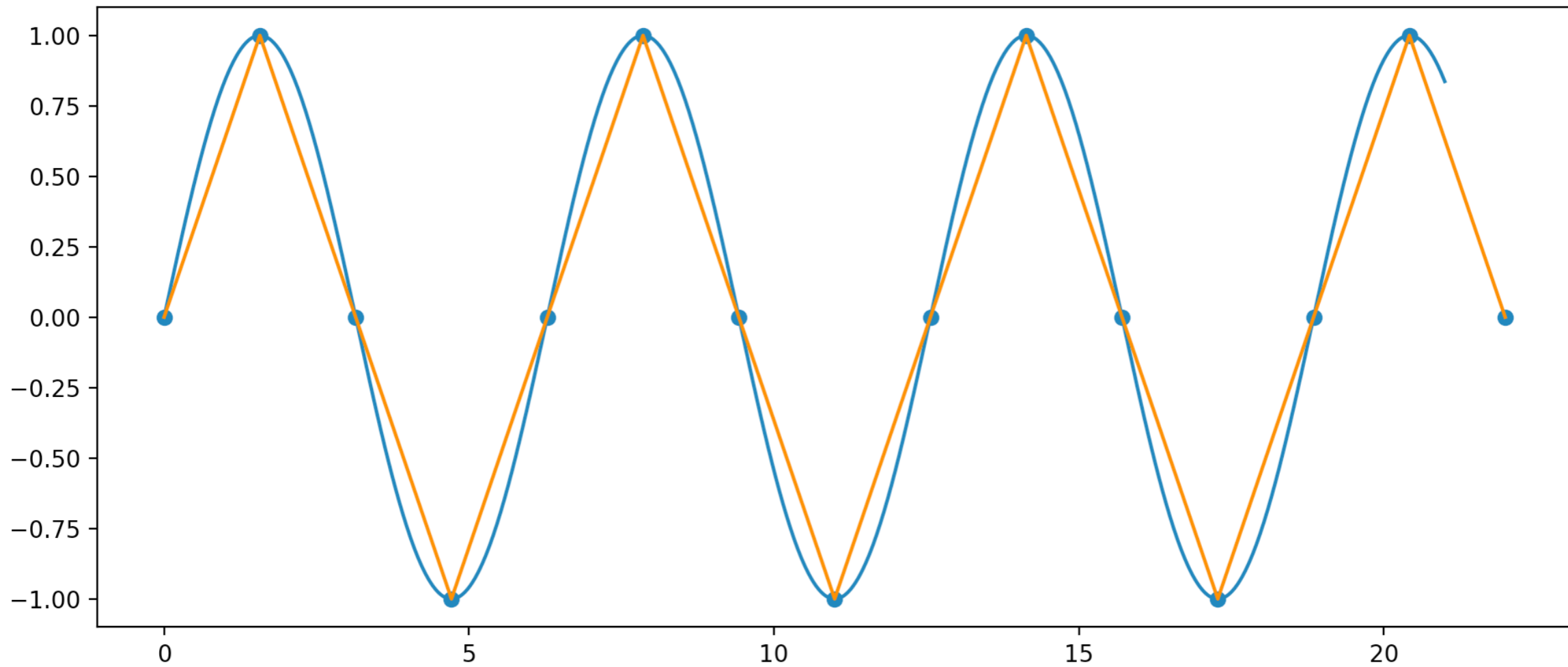

# Analog to Digital Conversion

$$f_s = 1.57f$$

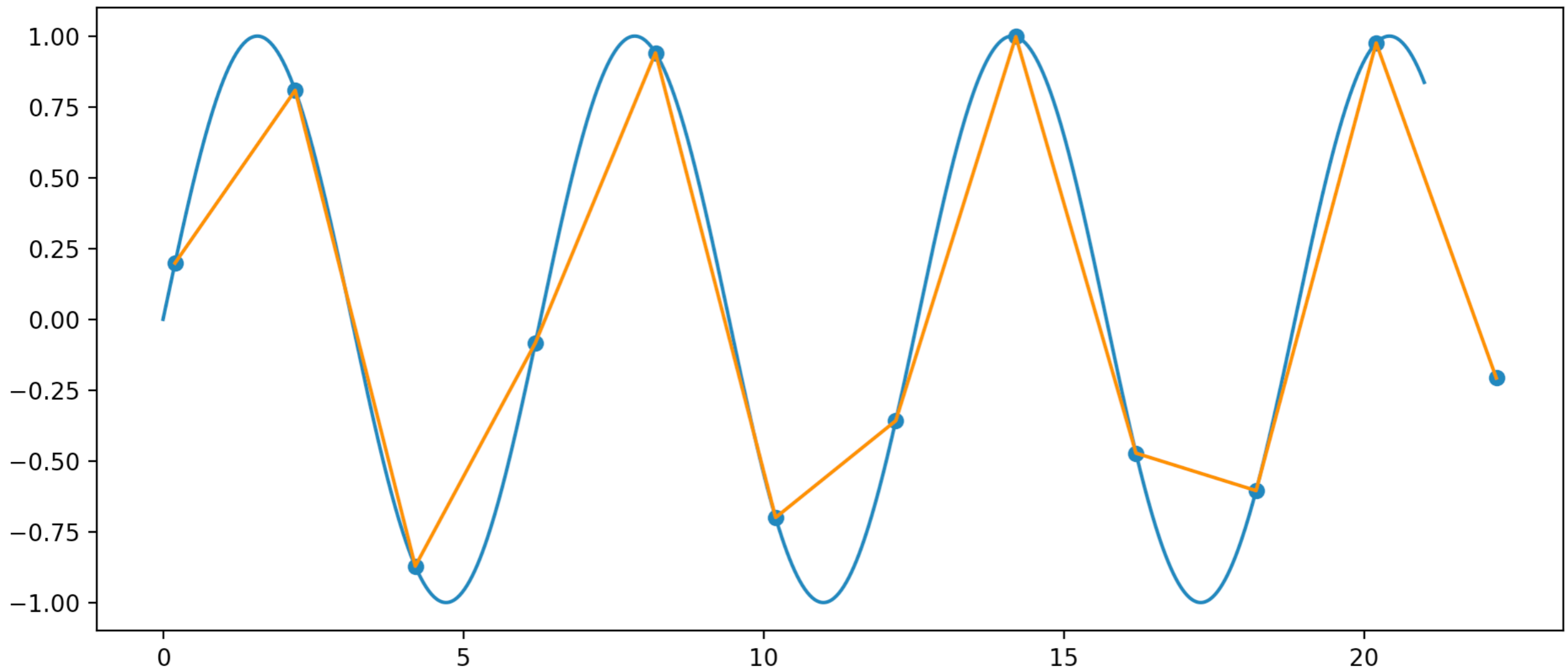

# Analog to Digital Conversion

$$f_s = 1.047f$$

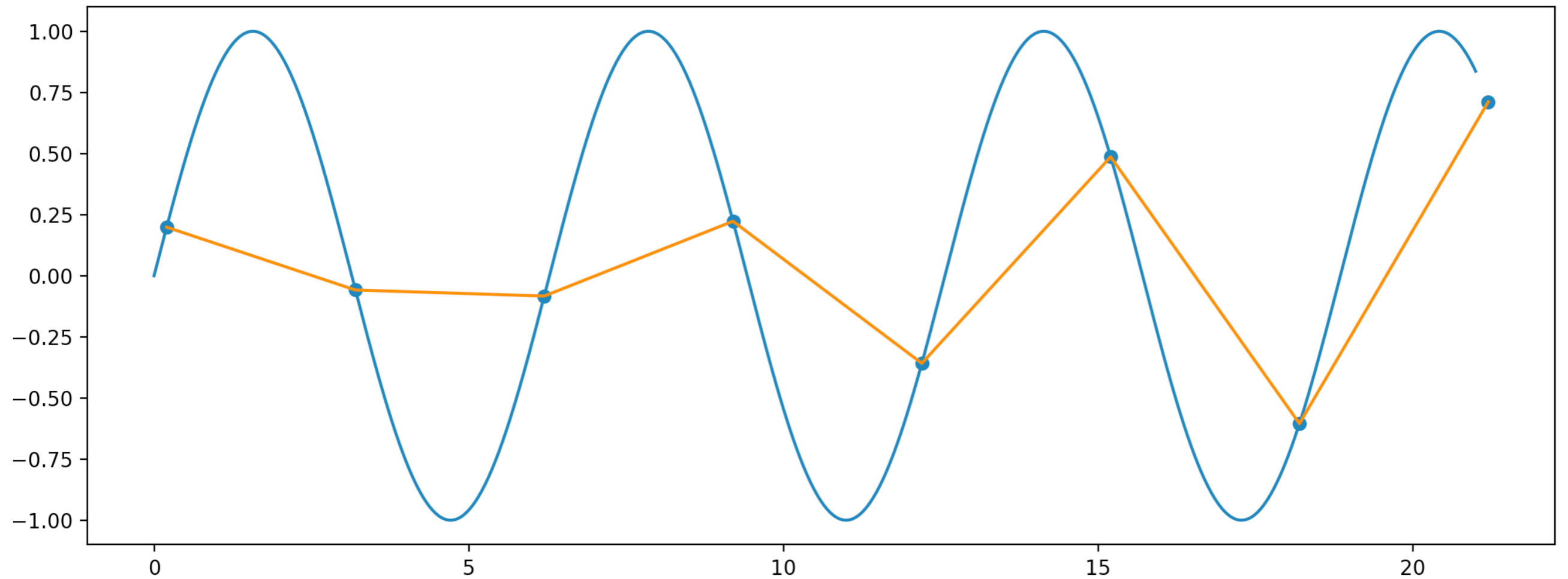

# Analog to Digital Conversion

- Encoding:
  - Bit-rate = Sampling rate  $\times$  number of bits per sample
    - $= f_s \times n_b$

# Analog to Digital Conversion

- Quiz:
  - We want to digitize the human voice. The human voice has frequencies between 0 and 4000 Hz. Assume 8b per sample. What is the minimum bit rate?
- Answer:
  - We need to sample at rate  $2 \times 4000\text{Hz}$
  - This gives  $8000 \cdot 8\text{bps} = 64\text{Kbps}$

# Analog to Digital Conversion

- Decoding:
  - Generate the quantized signal and smooth it via a low-pass filter

# Analog to Digital Conversion

- Apply Nyquist sampling theorem on channel
  1. Low-pass bandwidth channel with bandwidth  $B$
  2. Digital signal uses  $L$  levels ( $r = 1/\log_2(L)$ )
  3. Signal is passed through a low-pass filter to frequencies above  $B$  hz.
  4. Resulting signal is sampled at  $2 \times B$  samples per second
  5. We can do no better than quantizing with  $L$  levels
  6. Resulting bit rate is:

$$N_{\max} = 2 \times B \times \log_2(L) \text{ bps}$$

- This is the Nyquist Theorem

# Analog to Digital Conversion

- Quiz:
  - If the signal has  $L$  levels.
  - Given a desired data rate of  $N$  bps, calculate the required bandwidth?
- Answer:
  - $N_{\max} = 2 \times B \times \log_2(L)$
  - $B = \frac{N}{2 \times \log_2(L)}$



# Analog to Digital Conversion

- Delta Modulation
  - Store previous signal value
  - Compare with current value:
  - Go up: 1, Go down: 0

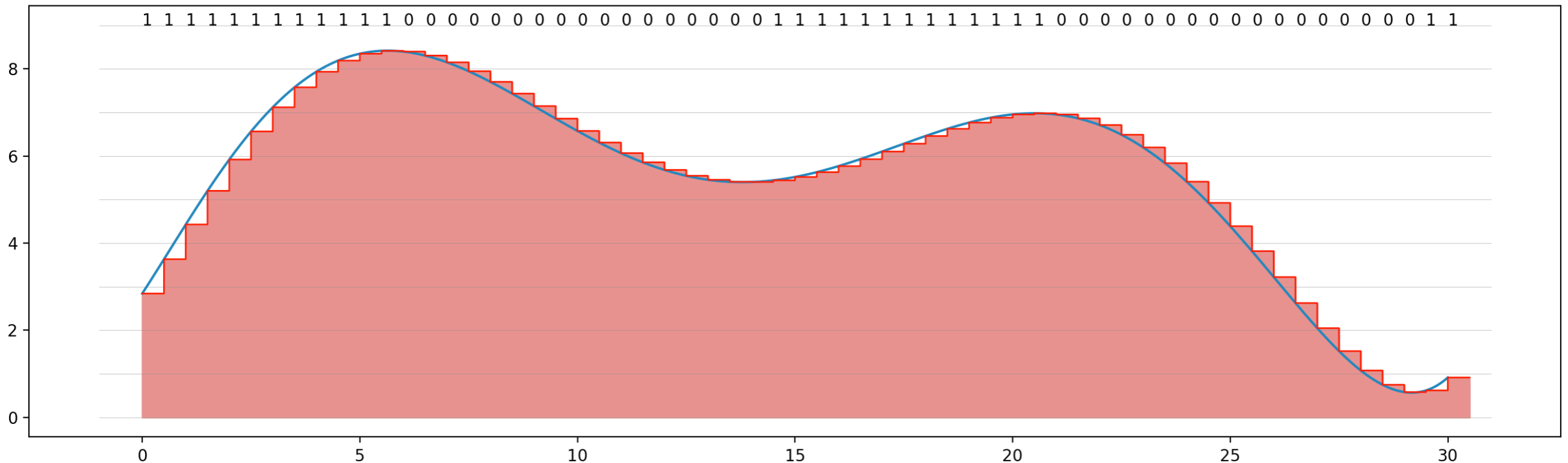

# Analog to Digital Conversion

- Delta modulation:
  - Better version: Adaptive delta modulation
    - Use more bits to represent the difference

# Transmission Modes

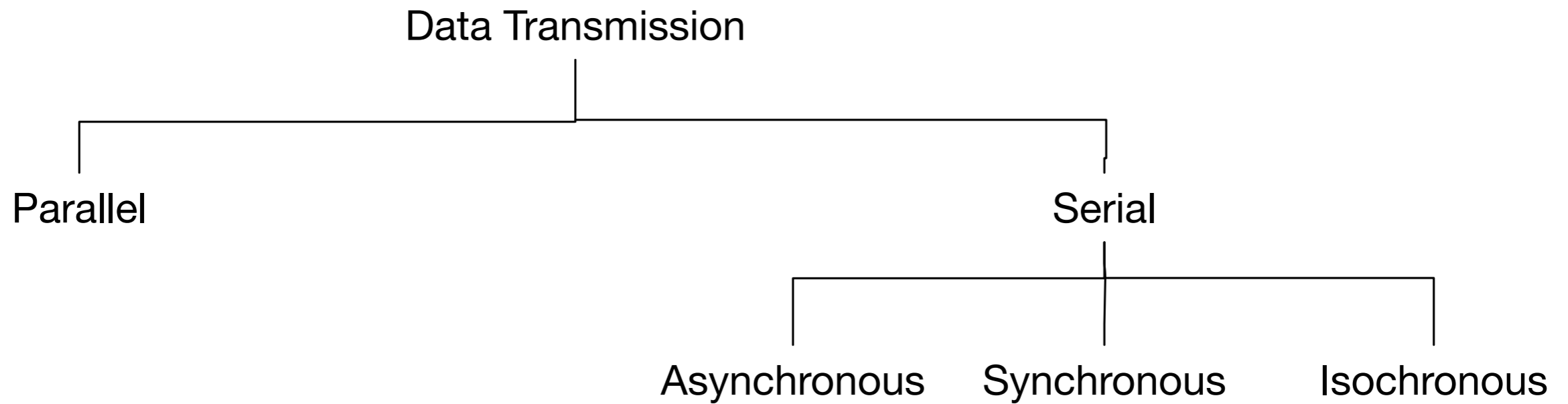

# Transmission Modes

- Parallel transmission:
  - Uses  $n$  wires to transmit  $n$  signals simultaneously
  - Can add more wires for control & clocking
- If there would be no electromagnetic interference:
  - Could transmit  $n$  times content then over a single wire

# Transmission Modes

- Asynchronous transmission
  - Timing is unimportant
  - Data is grouped
  - At the beginning of transmission of a group: start bit
  - Send data group: Each element at a fixed time
  - At the end: end bit(s)
  - Followed usually by a gap

# Transmission Modes

- Quiz:
  - Asynchronous transmission:
    - If we group data in bytes, how many bits are transferred?
- Answer:
  - 8 bits data + 1 start bit + 1 end bit (+ gap)

# Transmission Modes

- Synchronous transmission
  - Data is grouped into larger units: Data frames
  - Receiver uses timing to recover individual data units

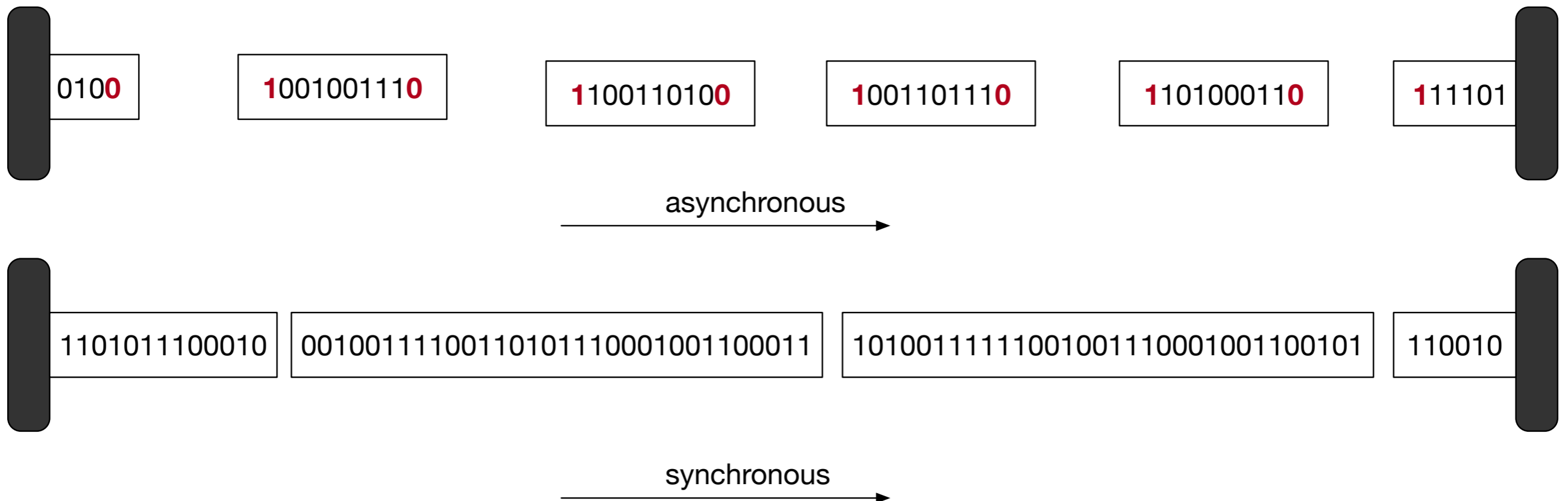

# Transmission Modes

- Isochronous:
  - Real-time audio / video: Uneven delays between frames is not accepted
  - Data arrives at a fixed rate



# **Analog Transmission**

# Analog Transmission

- Digital to analog conversion
- Analog to analog conversion

# Digital to Analog Conversion

- Convert digital data to bandpass analog signal

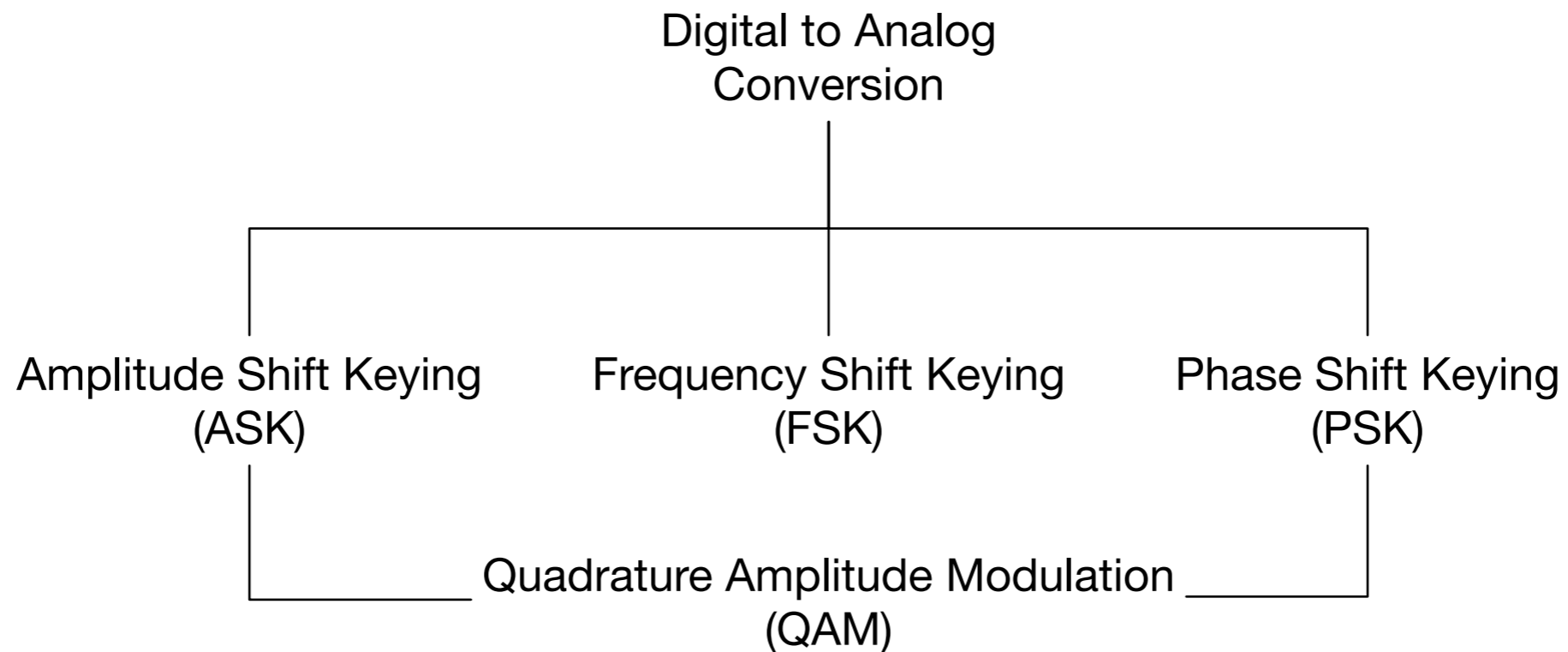

# Digital to Analog Conversion

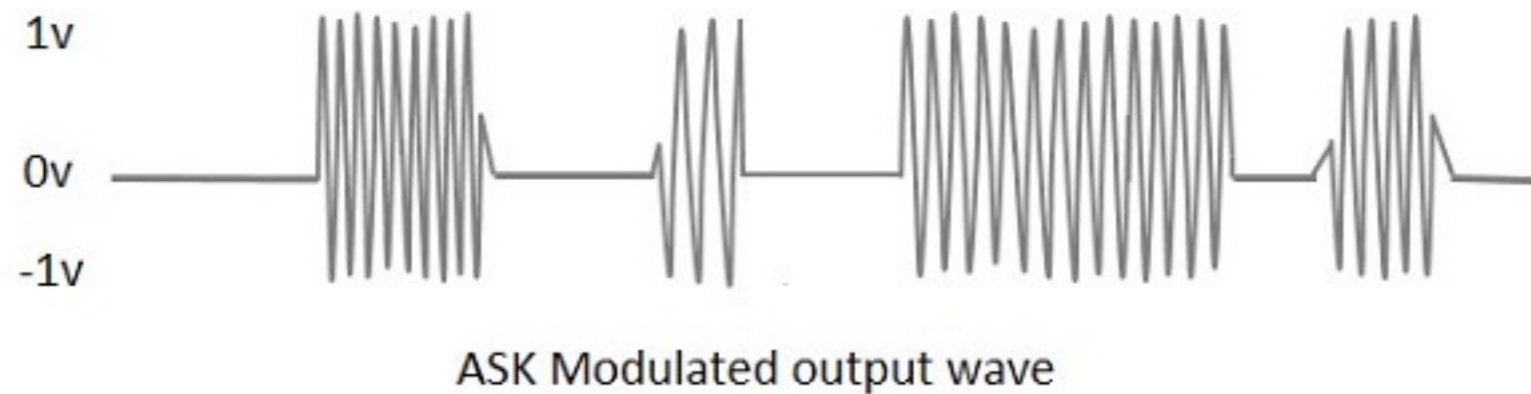
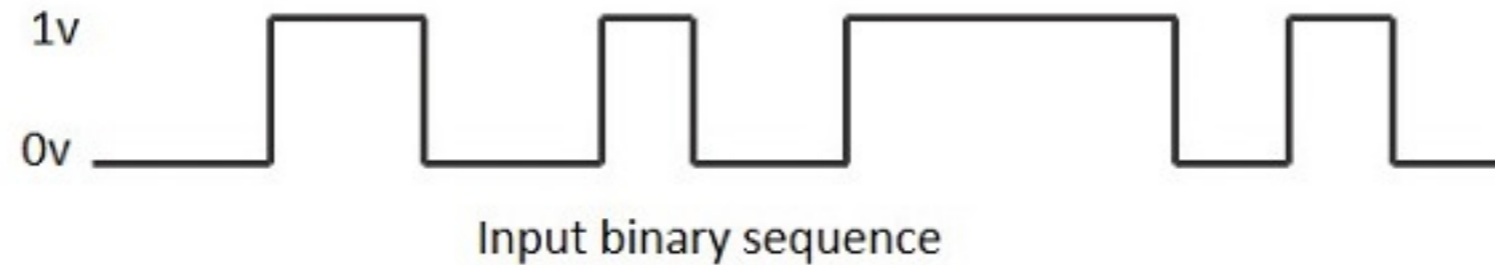

# Digital to Analog Conversion

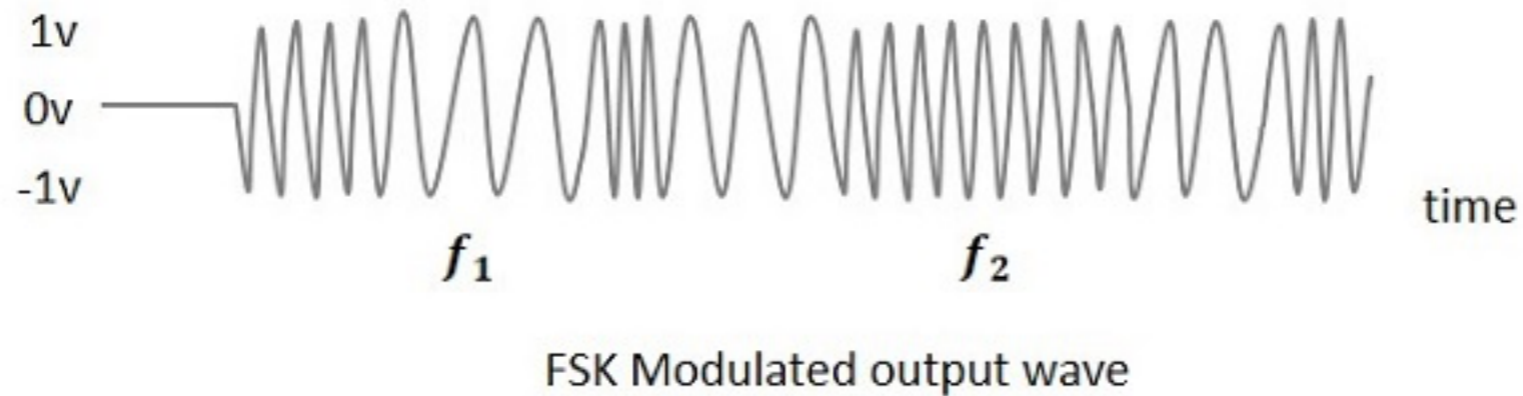
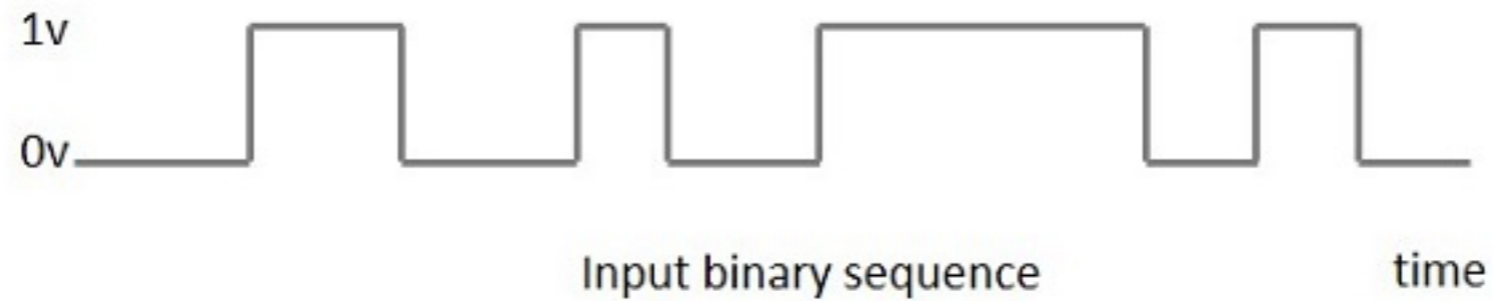

# Digital to Analog Conversion

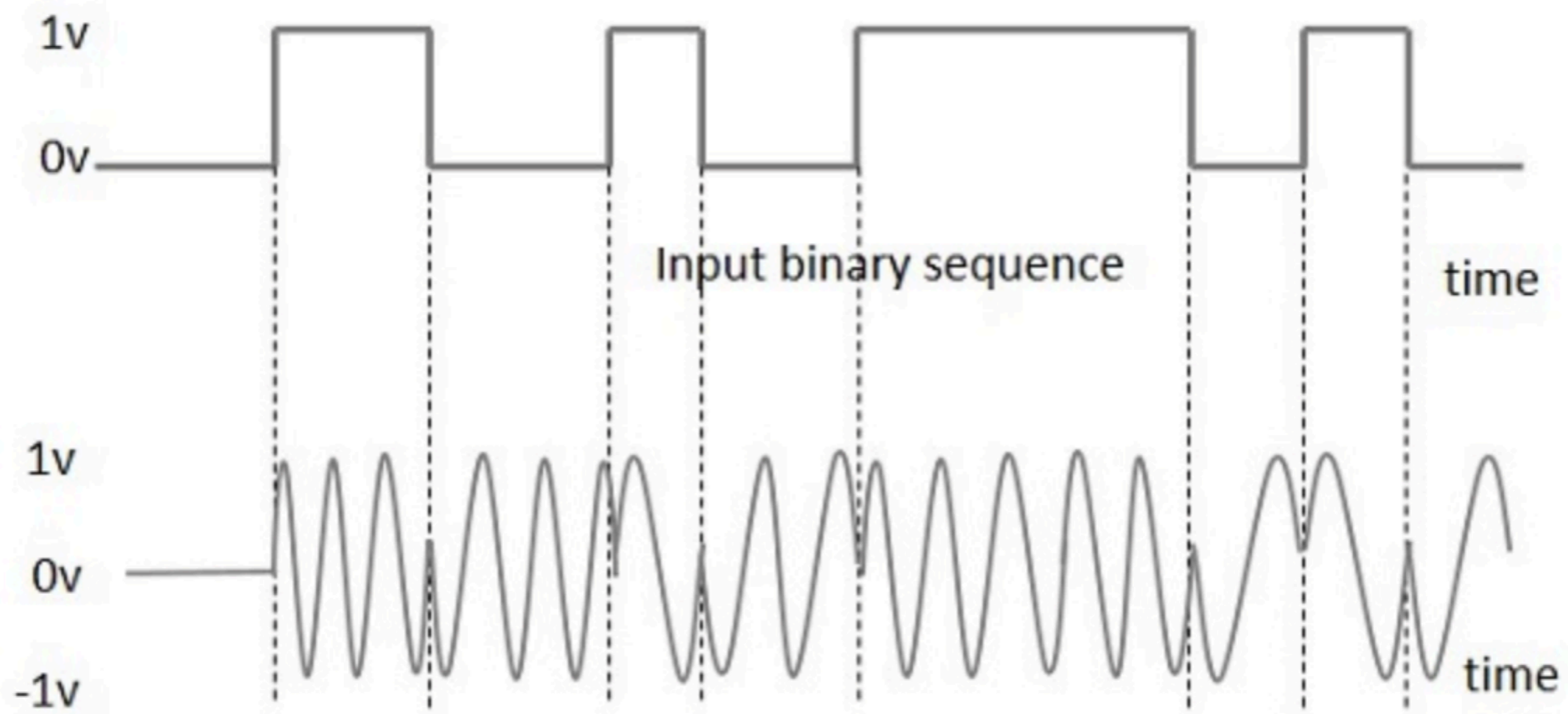

Binary Phase Shift Key

# Digital to Analog Conversion

- Quadrature Phase Shift Key
  - Use 2-bits at a time
  - Transmit one bit using amplitude modulation via signal with phase  $0^\circ$
  - Transmit one bit using amplitude modulation via signal with phase  $180^\circ$
  - Result is a sine wave with phase  $45^\circ$ ,  $-45^\circ$ ,  $135^\circ$ ,  $-135^\circ$

# Digital to Analog Conversion

- Can combine schemes to combine amplitude and phase
  - QPSK: 4 shifts
  - QAM-16: 16 combinations of amplitude and shift (4b per data symbol)
  - QAM-64: 64 combinations or 8 data bits per symbol

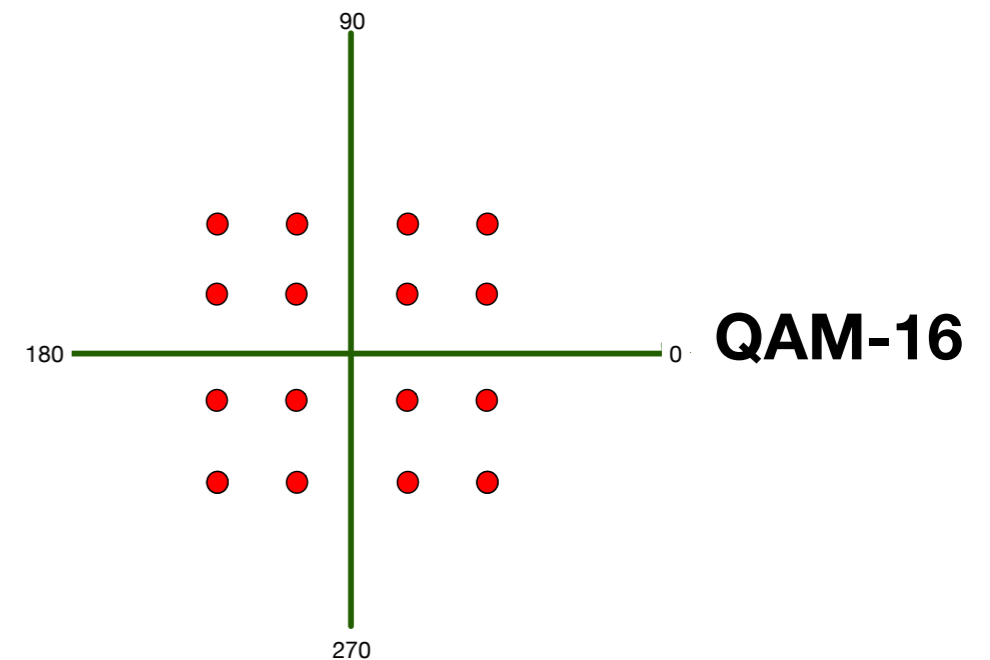
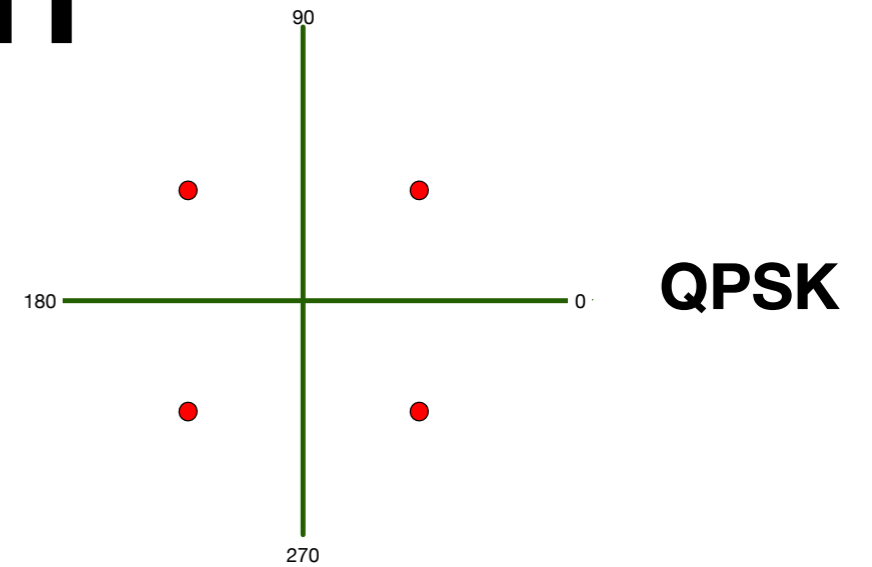



# Analog to Analog Conversion

- Analog to Analog
  - Make the signal fit for a bandpass medium
  - E.g. AM radio bands:

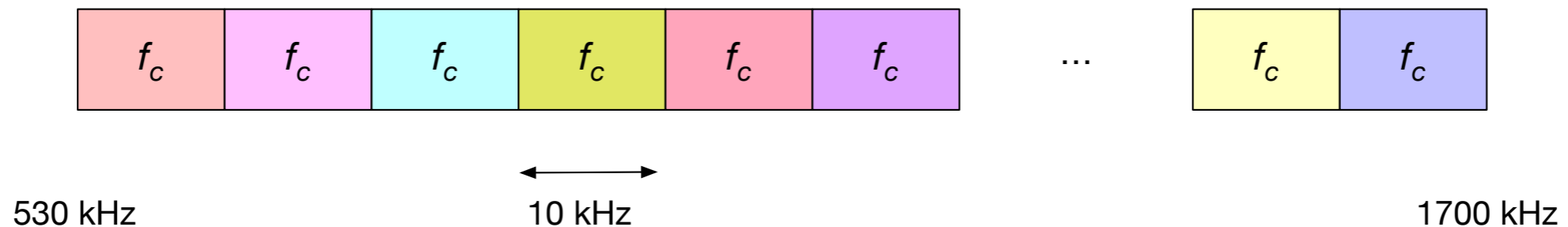

- Amplitude Modulation
- Frequency Modulation
- Phase Modulation

# Analog to Analog Conversion

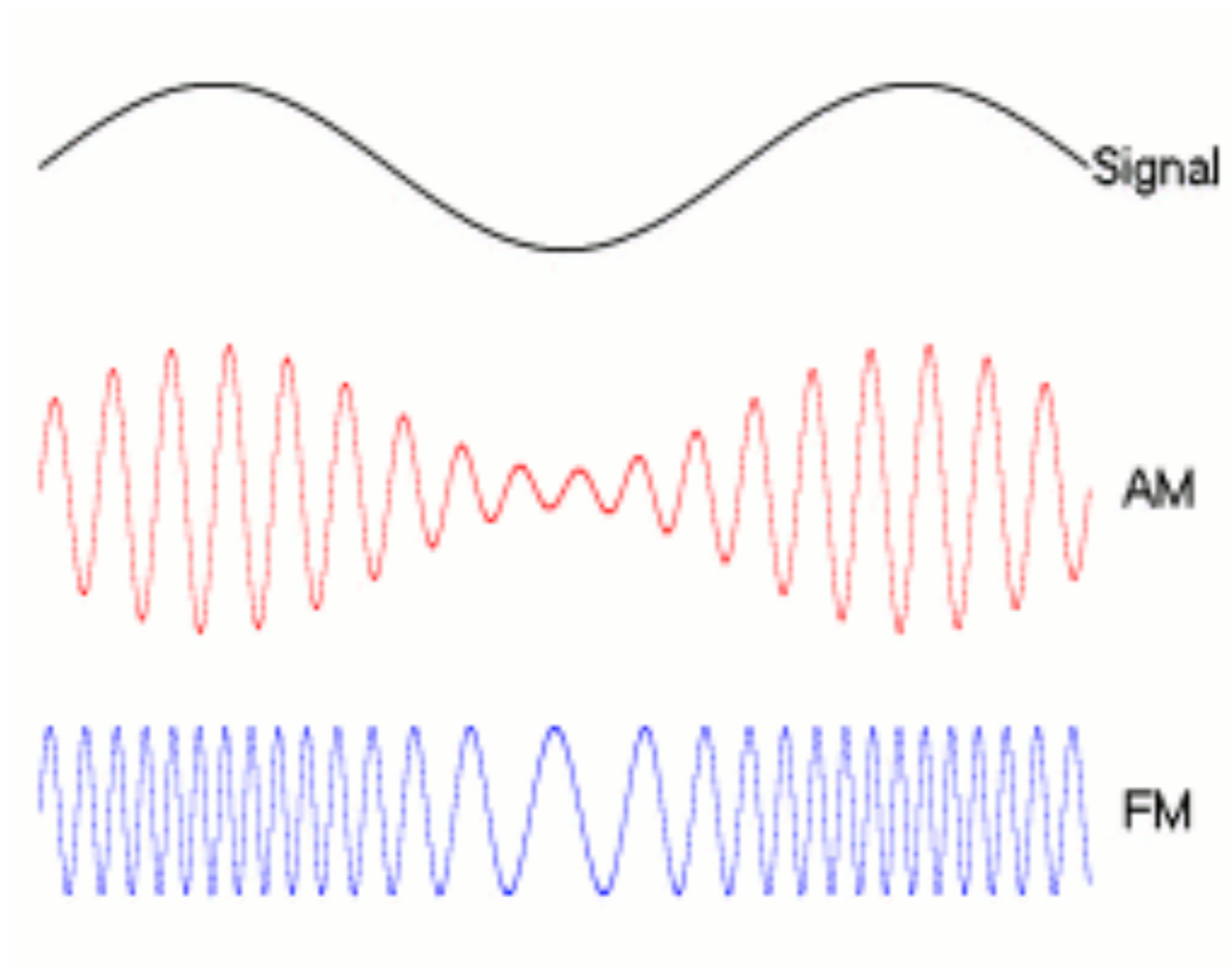

# Analog to Analog Conversion

- FM Radio Bands

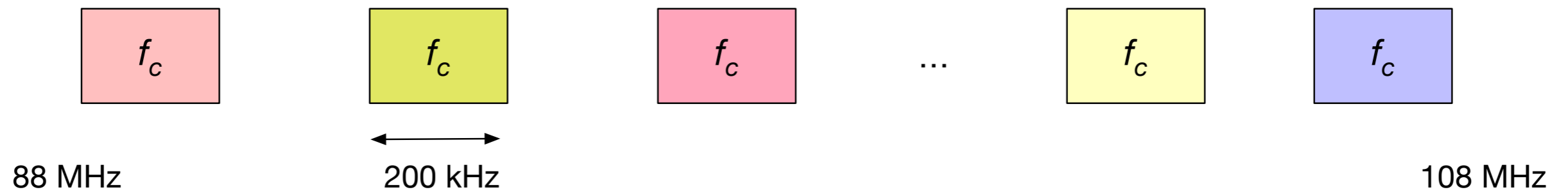

# Analog to Analog Conversion

- Phase modulation
  - Like FM with change in the frequency proportional to the derivative of the amplitude of the message signal

